

## Data Sheet

Customer:

Product: Metal Film Precision Resistor-CSR Series

Size: 0204/ 0207

Issued Date: 15-Jun-22

Edition: REV.D4



VIKING TECH CORPORATION  
光頡科技股份有限公司  
No.70 Guangfu N. Rd., Hukou  
Township, Hsinchu County 303,  
Taiwan

TEL:886-3-5972931  
FAX:886-3-5972935•886-3-5973494  
E-mail:sales@viking.com.tw

VIKING TECH CORPORATION KAOHSIUNG BRANCH  
光頡科技股份有限公司高雄分公司  
No.248-3, Sin-Sheng Rd., Cian-Jhen Dist., Kaohsiung,  
806, Taiwan

TEL:886-7-8217999  
FAX:886-7-8228229  
E-mail:sales@viking.com.tw

VIKING ELECTRONICS (WUXI) CO., LTD.  
光頡電子(無錫)有限公司  
No.22 Xixia Road, Machinery & Industry Park,  
National Hi-Tech Industrial Development Zone  
of Wuxi, Wuxi, Jiangsu Province, China  
Zip Code:214028  
TEL:86-510-85203339  
FAX:86-510-85203667•86-510-85203977  
E-mail:china@viking.com.tw

Produced by (QC)	Checked (QC)	Approved by (QC)	Prepared by (Sales)	Accepted by (Customer)
15-Jun-22	15-Jun-22	15-Jun-22		
<b>Alice Hsiao</b>	<b>Susan Huang</b>	<b>Susan Huang</b>		

**Metal Film Precision Resistor**  
**Metal Film Precision Resistor**



**■Features**

- Excellent overall stability
- Tight tolerance down to  $\pm 0.1\%$
- Extremely low TCR down to  $\pm 5 \text{ PPM}/^\circ\text{C}$
- High power rating up to 1 Watts

**■Applications**

- Telecommunication
- Medical Equipment
- Measurement/Testing Equipment

**■Construction & Dimension**

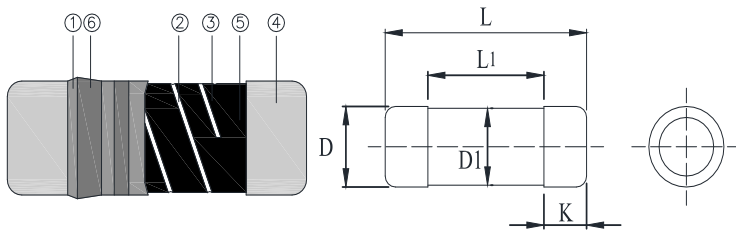

① Insulation Coating	④ Electrode Cap
② Trimming Line	⑤ Resistor Layer
③ Ceramic Rod	⑥ Marking

**■Derating Curve**

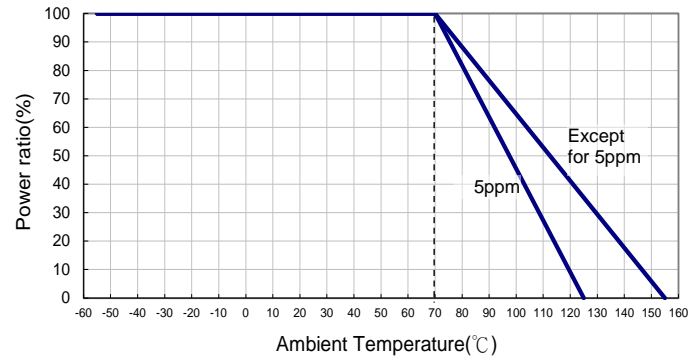

Type	L (mm)	L <sub>1 min.</sub> (mm)	ΦD (mm)	ΦD <sub>1</sub> (mm)	K (mm)	Weight 1,000EA (g)
CSR0204	3.50±0.2	1.7	1.40±0.15	D +0/-0.2	0.8±0.1	18.7
CSR0207	5.90±0.2	2.9	2.20±0.20	D +0/-0.2	1.3±0.1	80.9

**■Part Numbering**

Product Type	Dimensions (L×ΦD)	Resistance Tolerance	Packaging Code	TCR (PPM/°C)	Power Rating	Resistance
CSR	0204	D	T	D	V	1000
0204: 3.5x1.4 0207: 5.9x2.2	B: $\pm 0.1\%$ C: $\pm 0.25\%$ D: $\pm 0.5\%$ F: $\pm 1\%$ J: $\pm 5\%$	T: 7" Taping Reel S: 7" Taping Reel, Antistatic Tape* W: 13" Taping Reel M: 13" Taping Reel, Antistatic Tape*	S: $\pm 5$ B: $\pm 10$ N: $\pm 15$ C: $\pm 25$ D: $\pm 50$ E: $\pm 100$ - : No Specified	T: 1W U: 1/2W V: 1/4W G: 2/5W	0010: 1Ω 0100: 10Ω 1000: 100Ω 1001: 1KΩ 1004: 1MΩ R0R0: 0Ω R050: 0.05Ω R100: 0.1Ω 22R1: 22.1Ω	

\*\* Letter "R" is a decimal point.

\*Packaging Code "S" & "M" only for 0204 size product, not include 0207 size product.

**■ Soldering Condition (Ref. IPC/JEDEC J-STD-020 & J-STD-002)**

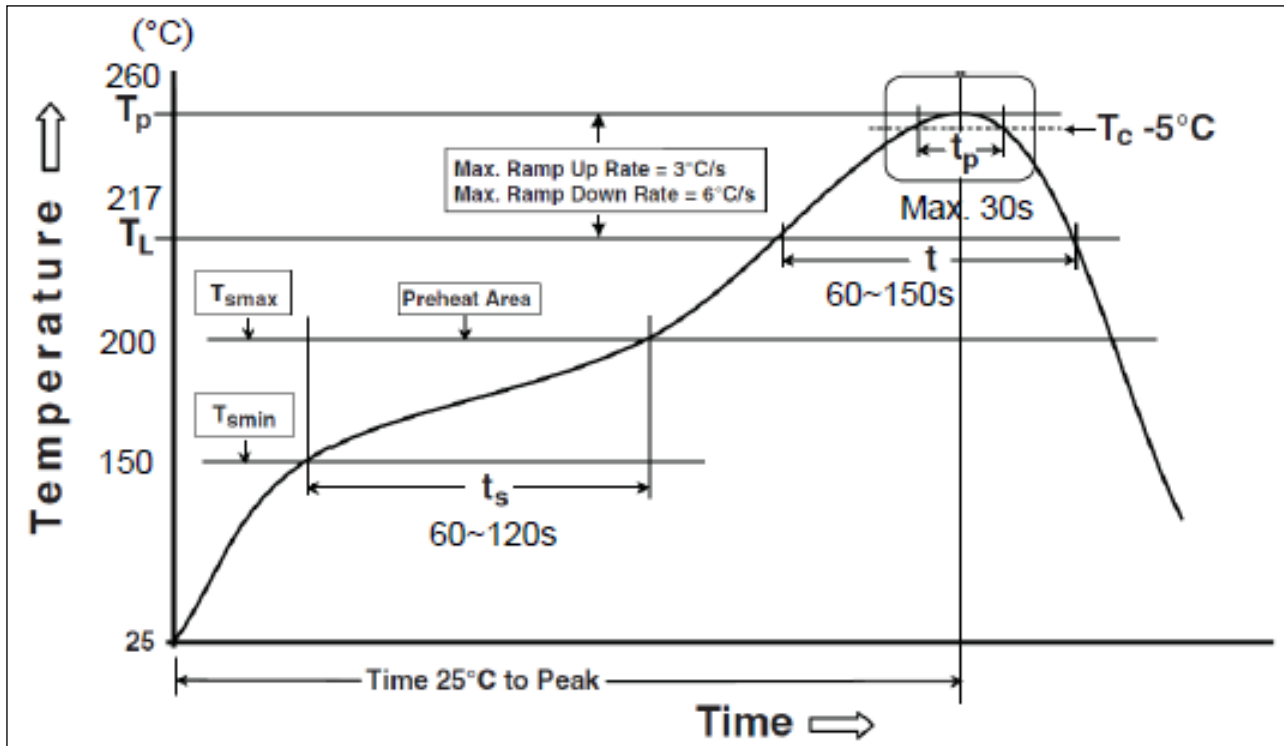

Reflow Profiles	
Profile Feature	Pb-Free Assembly
<b>Preheat</b>	
Min. Temperature (T <sub>smin</sub> )	150 °C
Max Temperature (T <sub>smax</sub> )	200 °C
Preheating time (t <sub>s</sub> ) from (T <sub>smin</sub> to T <sub>smax</sub> )	60-120 seconds
Ramp-up rate (T <sub>L</sub> to T <sub>p</sub> )	3 °C/second max.
Liquidous temperature (T <sub>L</sub> )	217 °C
Time (t <sub>L</sub> ) maintained above T <sub>L</sub>	60-150 seconds
Min. Peak temperature (T <sub>p</sub> min)	235°C
Max. Peak temperature (T <sub>p</sub> max)	260°C
Time (t <sub>p</sub> ) within 5 °C of the specified classification temperature (T <sub>c</sub> )	30 seconds max.
Ramp-down rate (T <sub>p</sub> to T <sub>L</sub> )	6 °C/second max.
Time 25 °C to peak temperature	8 minutes max.

**Standard Electrical Specifications**

Item Type	Power Rating at 70°C	Operating Temp. Range	Max. Operating Voltage	Max. Overload Voltage	Resistance Range					TCR (PPM/°C)
					±0.1%	±0.25%	±0.5%	±1%	±5%	
0204	1/4W	-55 ~ +125°C	200V	400V	10Ω-332KΩ		-			±5
					10Ω-20KΩ					±10
					10Ω-300KΩ					±15
		-55 ~ +155°C	200V	400V	10Ω-1MΩ	10Ω-3.4MΩ	1Ω-4.7MΩ		±25	
					10Ω-1MΩ	1Ω-3.4MΩ	0.2Ω-10MΩ		±50	
					-		0.1Ω-10MΩ		±100	
Jumper:2A	-		0Ω(<15mΩ)		-					
0207	1/2W	-55 ~ +125°C	300V	600V	10Ω-332KΩ		-			±5
					10Ω-20KΩ					±10
					10Ω-300KΩ					±15
		-55 ~ +155°C	300V	600V	10Ω-1MΩ	10Ω-3.4MΩ	1Ω-4.7MΩ		±25	
					10Ω-1MΩ	1Ω-3.4MΩ	0.2Ω-10MΩ		±50	
					-		0.1Ω-10MΩ		±100	
Jumper:4A	-		0Ω(<15mΩ)		-					

**High Power Rating Electrical Specifications**

Item Type	Power Rating at 70°C	Operating Temp. Range	Max. Operating Voltage	Max. Overload Voltage	Resistance Range					TCR (PPM/°C)
					±0.1%	±0.25%	±0.5%	±1%	±5%	
0204	2/5W	-55 ~ +125°C	200V	400V	10Ω-332KΩ		-			±5
					10Ω-20KΩ					±10
					10Ω-300KΩ					±15
		-55 ~ +155°C	200V	400V	10Ω-1MΩ	10Ω-3.4MΩ	1Ω-4.7MΩ		±25	
					10Ω-1MΩ	1Ω-3.4MΩ	0.2Ω-10MΩ		±50	
					-		0.1Ω-10MΩ		±100	
0207	1W	-55 ~ +125°C	300V	600V	10Ω-332KΩ		-			±5
					10Ω-20KΩ					±10
					10Ω-300KΩ					±15
		-55 ~ +155°C	300V	600V	10Ω-1MΩ	10Ω-3.4MΩ	1Ω-4.7MΩ		±25	
					10Ω-1MΩ	1Ω-3.4MΩ	0.2Ω-10MΩ		±50	
					-		0.1Ω-10MΩ		±100	

Operating Voltage= $\sqrt{P \cdot R}$  or Max. Operating Voltage listed above, whichever is lower.

Overload Voltage= $2.5 \cdot \sqrt{P \cdot R}$  or Max. Overload Voltage listed above, whichever is lower.

■ Viking is capable of manufacturing the optional spec based on customer's requirement.

**Environmental Characteristics**

Item	Requirement		Test Method
	5% and Below	Jumper	
Temperature Coefficient of Resistance (T.C.R.)	As Spec		<b>JIS-C-5201-1 4.8</b> <b>IEC-60115-1 4.8</b> At 25°C/-55°C and 25°C/+125°C, 25°C is the reference temperature 5ppm: At 25°C/-10°C and 25°C/+85°C, 25°C is the reference temperature
Short Time Overload	$\pm(0.15\%+0.05\Omega)$ 5ppm: $\pm(0.05\%+0.01\Omega)$	<15mΩ	<b>JIS-C-5201-1 4.13</b> <b>IEC-60115-1 4.13</b> RCWV*2.5 or Max. Overload Voltage whichever is lower for 5 seconds
Insulation Resistance	≥10G		<b>JIS-C-5201-1 4.6</b> <b>IEC-60115-1 4.6</b> Max. Overload Voltage for 1 minute

**Metal Film Precision Resistor**

Endurance	$\pm(0.5\%+0.05\Omega)$ 5ppm: $\pm(0.25\%+0.01\Omega)$	<15m $\Omega$	<b>JIS-C-5201-1 4.25</b> <b>IEC-60115-1 4.25.1</b> 70 $\pm$ 2 $^{\circ}$ C, RCWV for 1000 hrs with 1.5 hrs "ON" and 0.5 hr "OFF"
Damp Heat with Load	$\pm(1.0\%+0.05\Omega)$ 5ppm: $\pm(0.25\%+0.01\Omega)$	<15m $\Omega$	<b>JIS-C-5201-1 4.24</b> <b>IEC-60115-1 4.24</b> 40 $\pm$ 2 $^{\circ}$ C, 90~95% R.H., RCWV for 1000 hrs with 1.5 hrs "ON" and 0.5 hr "OFF"
Dry Heat	$\pm(1.0\%+0.05\Omega)$ 5ppm: $\pm(0.25\%+0.01\Omega)$	<15m $\Omega$	<b>JIS-C-5201-1 4.23</b> <b>IEC-60115-1 4.23.2</b> at +125 $^{\circ}$ C/+155 $^{\circ}$ C for 1000 hrs
Bending Strength	$\pm(0.5\%+0.05\Omega)$ 5ppm: $\pm(0.1\%+0.01\Omega)$	<15m $\Omega$	<b>JIS-C-5201-1 4.33</b> <b>IEC-60115-1 4.33</b> Bending once for 5 seconds with 2mm
Solderability	95% min. coverage		<b>JIS-C-5201-1 4.17</b> <b>IEC-60115-1 4.17</b> 245 $\pm$ 5 $^{\circ}$ C for 3 seconds
Resistance to Soldering Heat	$\pm(0.5\%+0.05\Omega)$ 5ppm: $\pm(0.05\%+0.01\Omega)$	<15m $\Omega$	<b>JIS-C-5201-1 4.18</b> <b>IEC-60115-1 4.18</b> 260 $\pm$ 5 $^{\circ}$ C for 10 seconds
Voltage Proof	No breakdown or flashover		<b>JIS-C-5201-1 4.7</b> <b>IEC-60115-1 4.7</b> 1.42 times Max. Operating Voltage for 1 minute
Leaching	Individual leaching area $\leq$ 5% Total leaching area $\leq$ 10%		<b>JIS-C-5201-1 4.18</b> <b>IEC-60068-2-58 8.2.1</b> 260 $\pm$ 5 $^{\circ}$ C for 30 seconds
Rapid Change of Temperature	$\pm(0.5\%+0.05\Omega)$ 5ppm: $\pm(0.2\%+0.01\Omega)$	<15m $\Omega$	<b>JIS-C-5201-1 4.19</b> <b>IEC-60115-1 4.19</b> -55 $^{\circ}$ C to +125 $^{\circ}$ C/+155 $^{\circ}$ C, 5 cycles

RCWV(Rated Continuous Working Voltage)= $\sqrt{P \cdot R}$  or Max. Operating Voltage whichever is lower.

■ **Storage Temperature: 15~28 $^{\circ}$ C; Humidity < 80%RH**

■ **Shelf Life: 2 years from production date.**

**Metal Film Precision Resistor**

**■ Packaging**

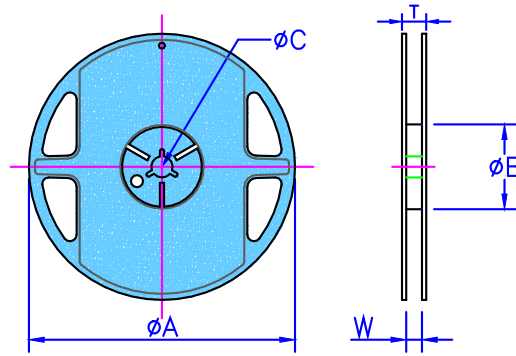

Packaging Quantity & Reel Specifications

Type	Reel Diameter	$\Phi A$ (mm)	$\Phi B$ (mm)	$\Phi C$ (mm)	W (mm)	T (mm)	Emboss Plastic Tape (EA)
CSR0204	7 inch	178.5±1.5	60.0+1.0	13.0±0.2	9.0±0.5	12.5±0.5	3,000
	13 inch	330±1.0	100±0.5	13.0±0.2	9.5±0.5	13.5±0.5	10,000
CSR0207	7 inch	178.5±1.5	60.0+1.0	13.0±0.5	13.0±0.5	15.5±0.5	2,000
	13 inch	330±1.0	99±0.5	13.5±0.5	13.4±1	17.8±1	6,000

Emboss Plastic Tape Specifications

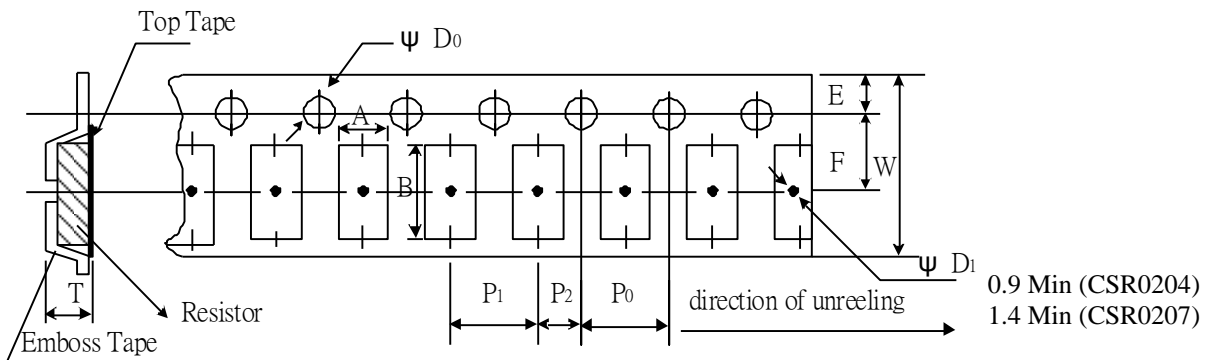

Type	A (mm)	B (mm)	W (mm)	E (mm)	F (mm)	$P_0$ (mm)	$P_1$ (mm)	$P_2$ (mm)	$\Phi D_0$ (mm)	T (mm)
CSR0204	1.55±0.20	3.65±0.20	8.0±0.10	1.75±0.10	3.50±0.05	4.00±0.10	4.00±0.10	2.00±0.05	1.50+0.10	1.80±0.10
CSR0207	2.40±0.10	6.15±0.10	12.0±0.10	1.75±0.10	5.50±0.05	4.00±0.10	4.00±0.10	2.00±0.05	1.50+0.10	2.70±0.10

**■ Recommend Land Pattern**

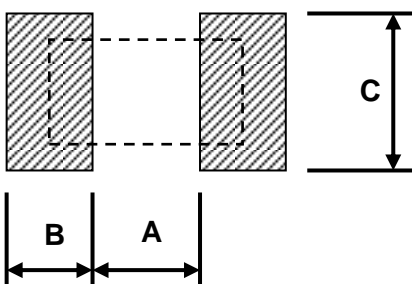

Type	A (mm)	B (mm)	C (mm)
CSR0204	1.6	1.2	1.6
CSR0207	3.0	1.7	2.4

**■ Pulse withstanding capacity**

The single impulse graph is the result of the impulse of rectangular shape applied. The limit of acceptance was a shift in resistance of less than 1% from the initial value. The power applied was subject to the restrictions of the maximum permissible impulse voltage graph shown.

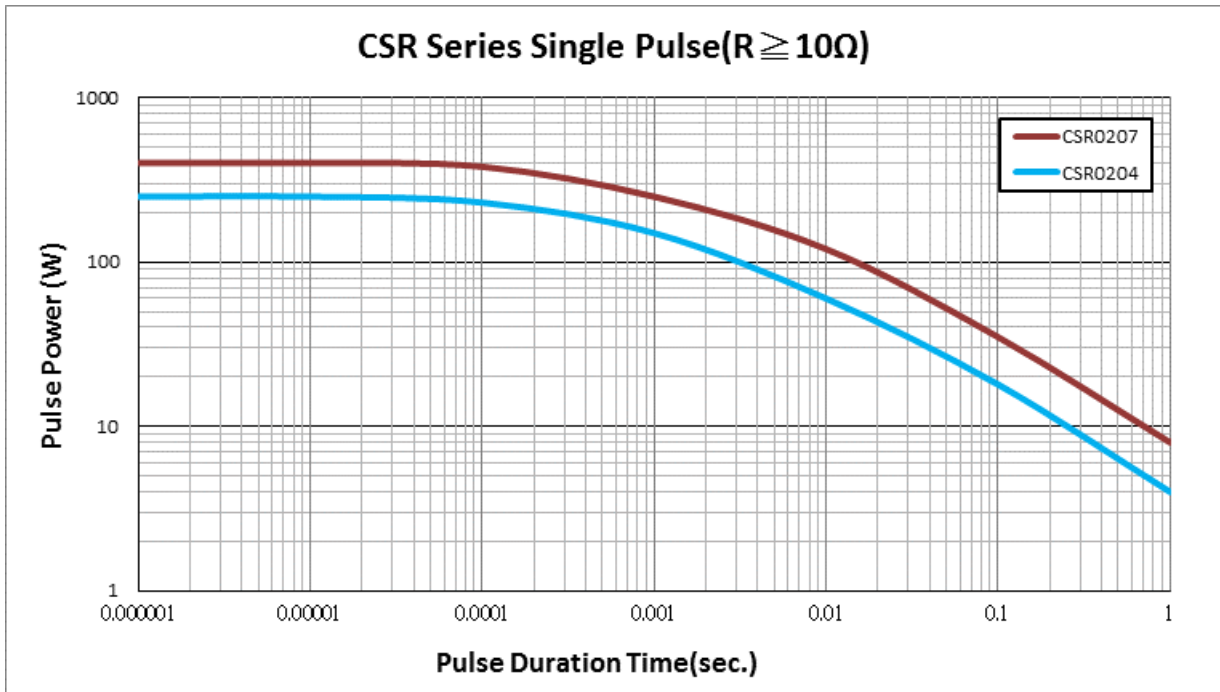
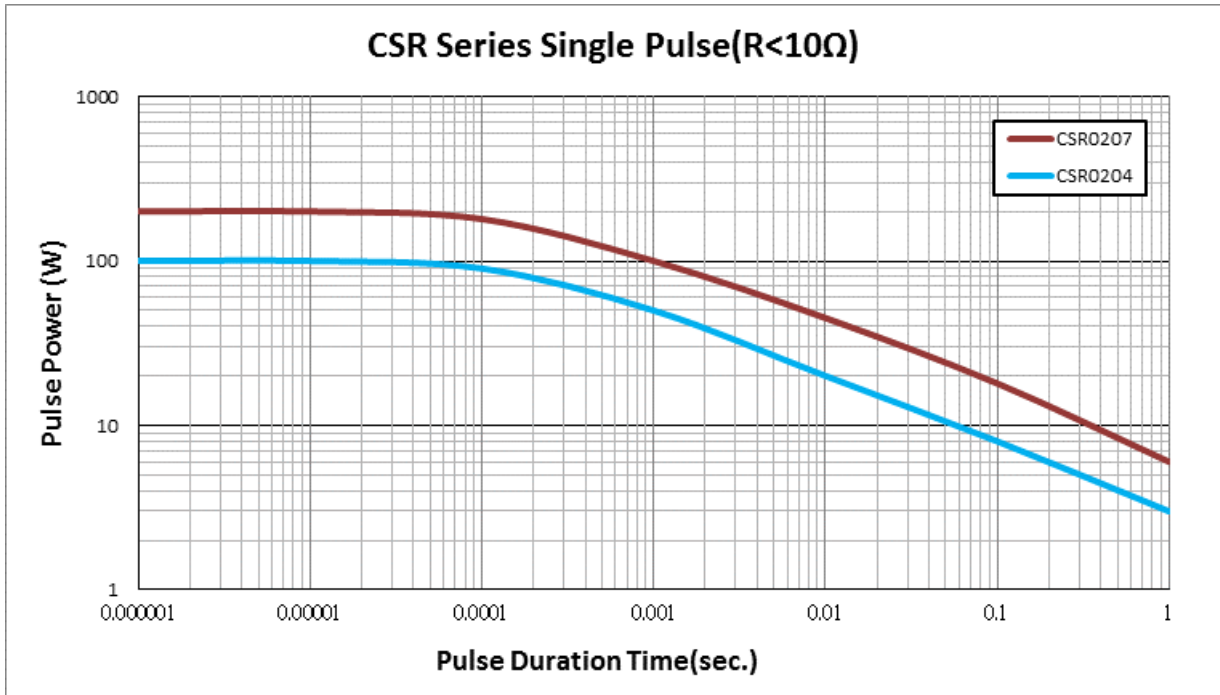

**Continuous Pulse**

The continuous load graph was obtained by applying repetitive rectangular pulses where the pulse period was adjusted so that the average power dissipated in the resistor was equal to its rated power at 70°C. Again the limit of acceptance was a shift in resistance of less than 1% from the initial value.

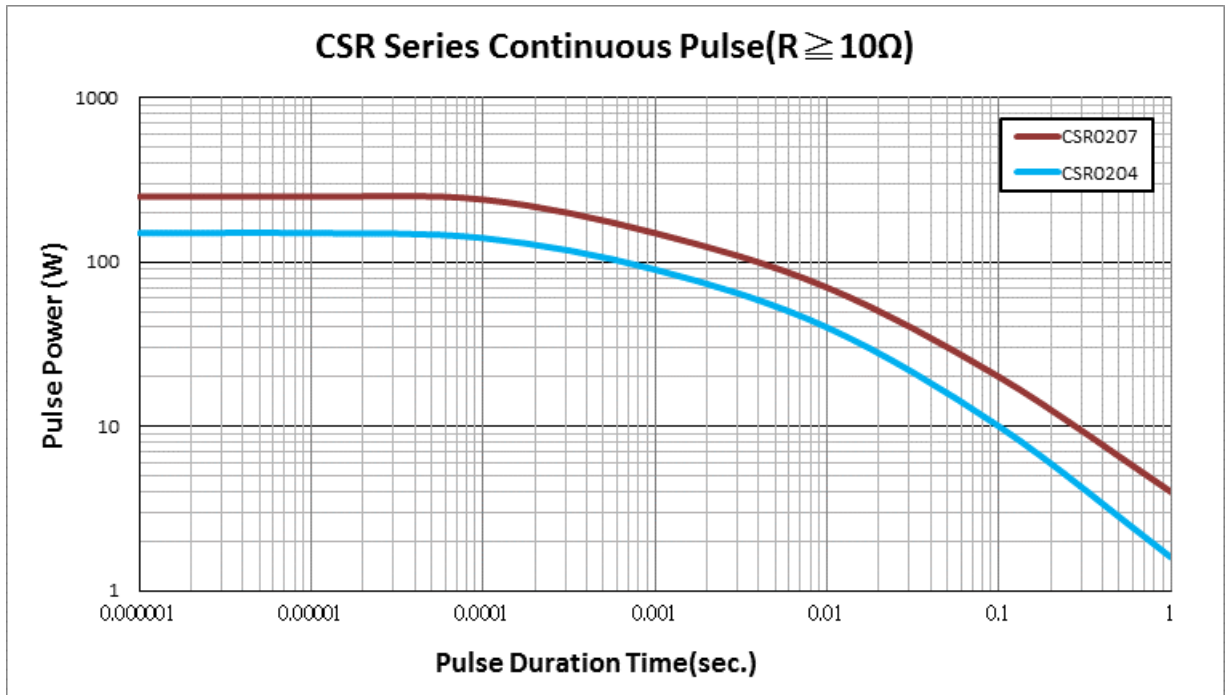
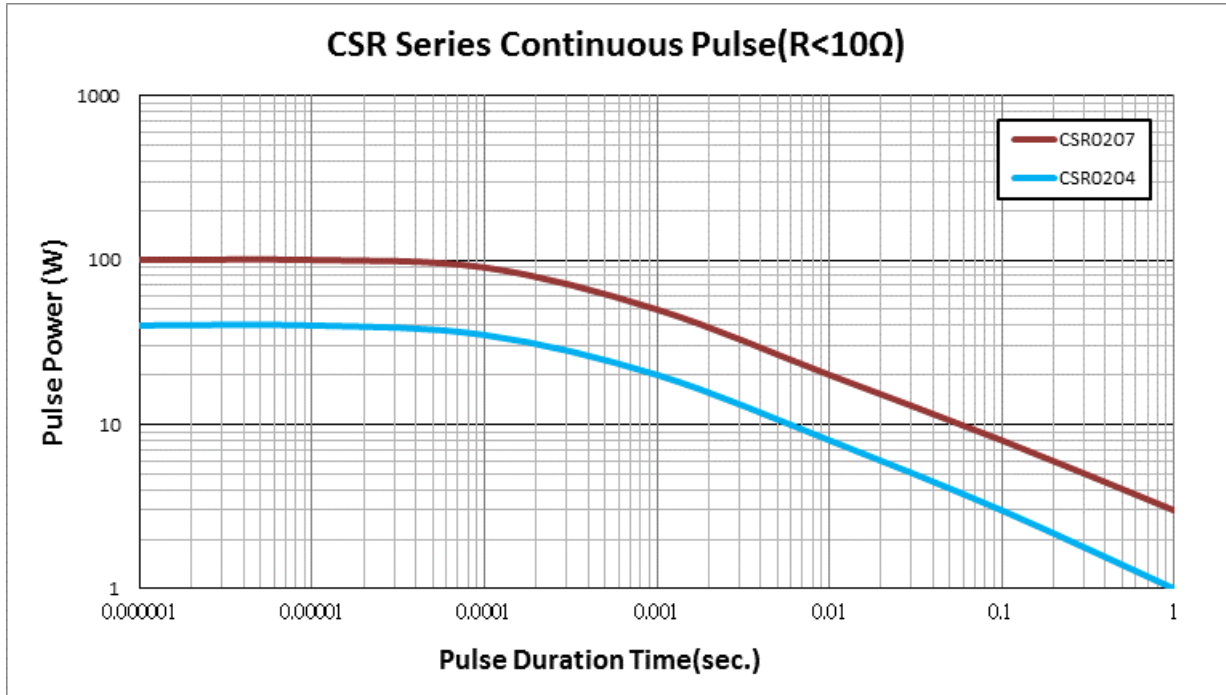



**Frequency behavior**

Resistors are designed to function according to ohmic laws. This is basically true of resistors for frequencies up to 100kHz. At higher frequencies, there is an additional contribution to the impedance by an ideal resistor switched in series with a coil and both switched parallel to a capacitor. The values of the capacitance and inductance are mainly determined by the dimensions of the terminations and the conductive path length.

The environment surrounding components has a large influence on the behavior of the component on the printed-circuit board.

**Frequency vs. Impedance  
CSR Series(CSR0204)**

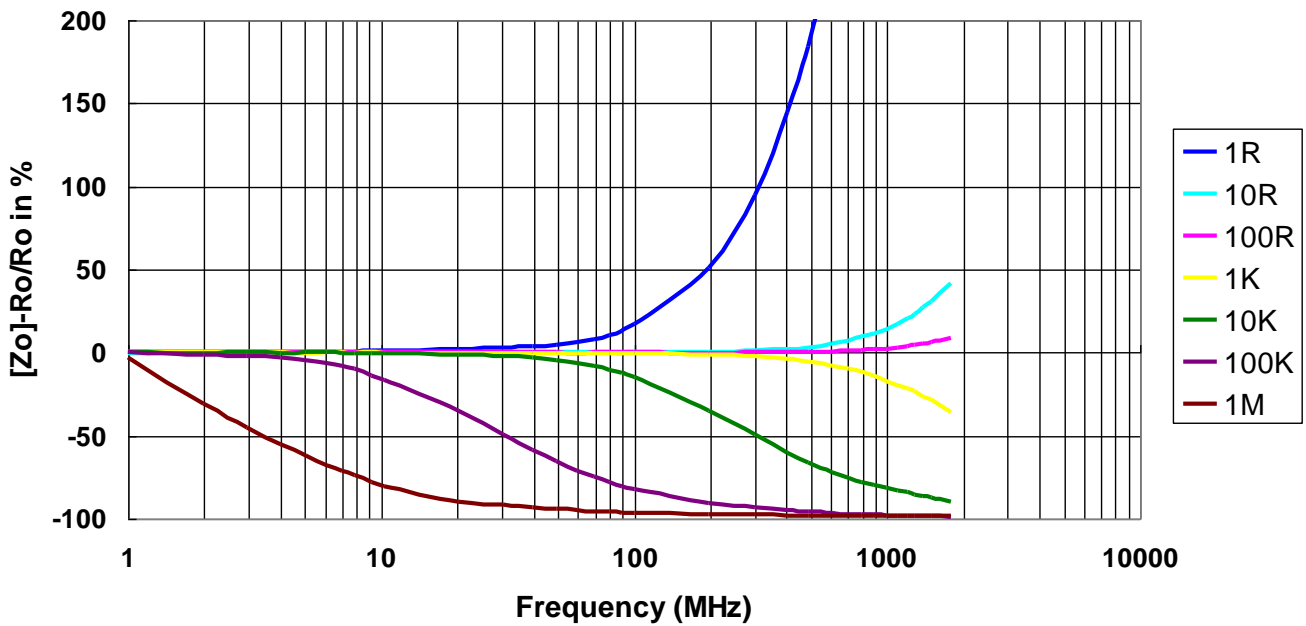

**Frequency vs. Phase Angle  
CSR Series(CSR0204)**

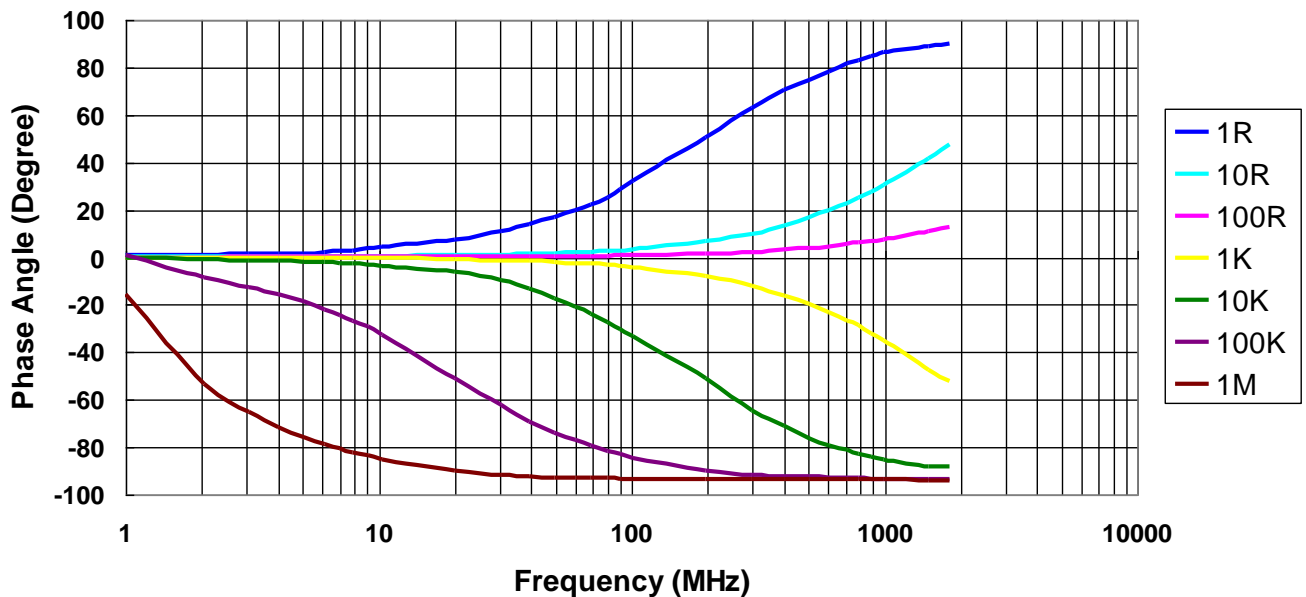

### Frequency vs. Impedance CSR Series(CSR0207)

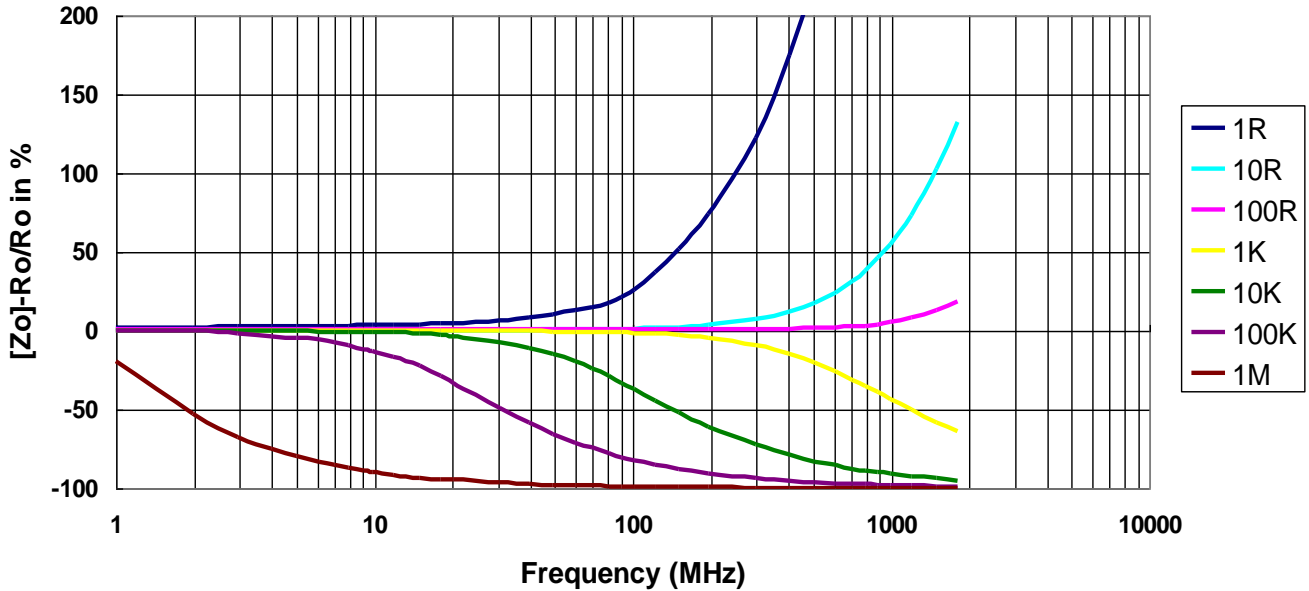

### Frequency vs. Phase Angle CSR Series(CSR0207)

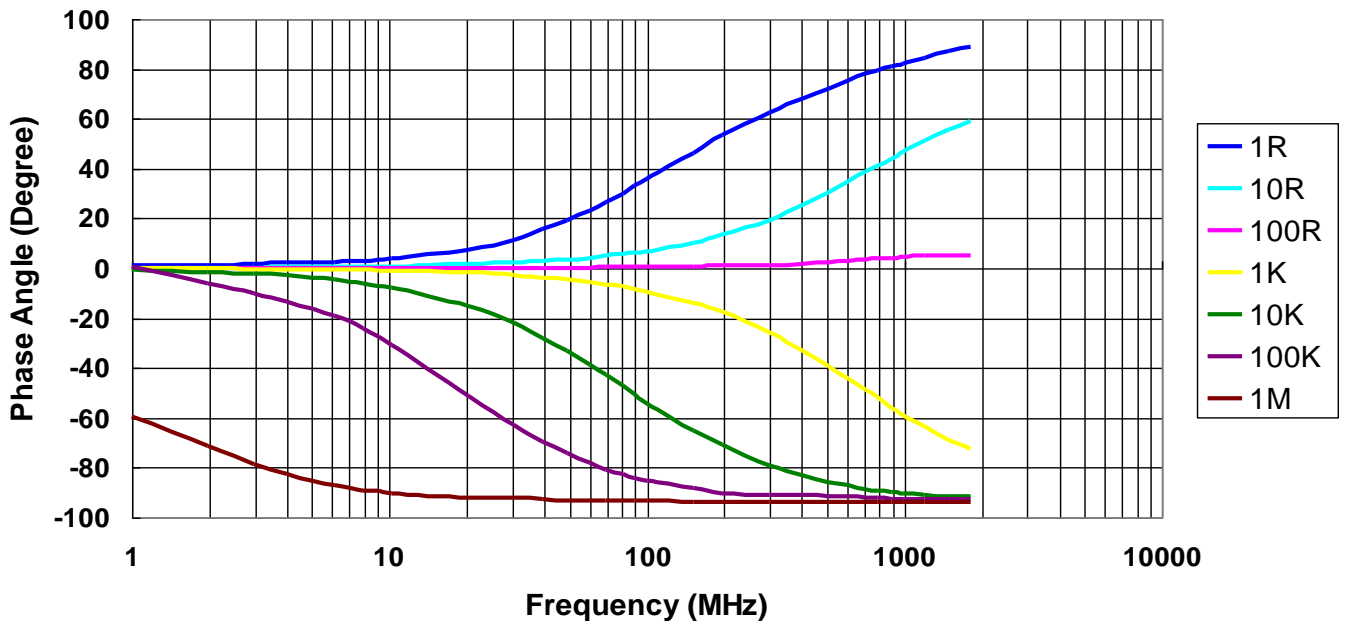

**■ Lightning Surge**

Resistors are tested in accordance with IEC 60 115-1 using both 1.2/50us and 10/700us pulse shapes. The limit of acceptance is a shift in resistance of less than 0.5% from the initial value.

**1.2/50μs Lightning Surge**

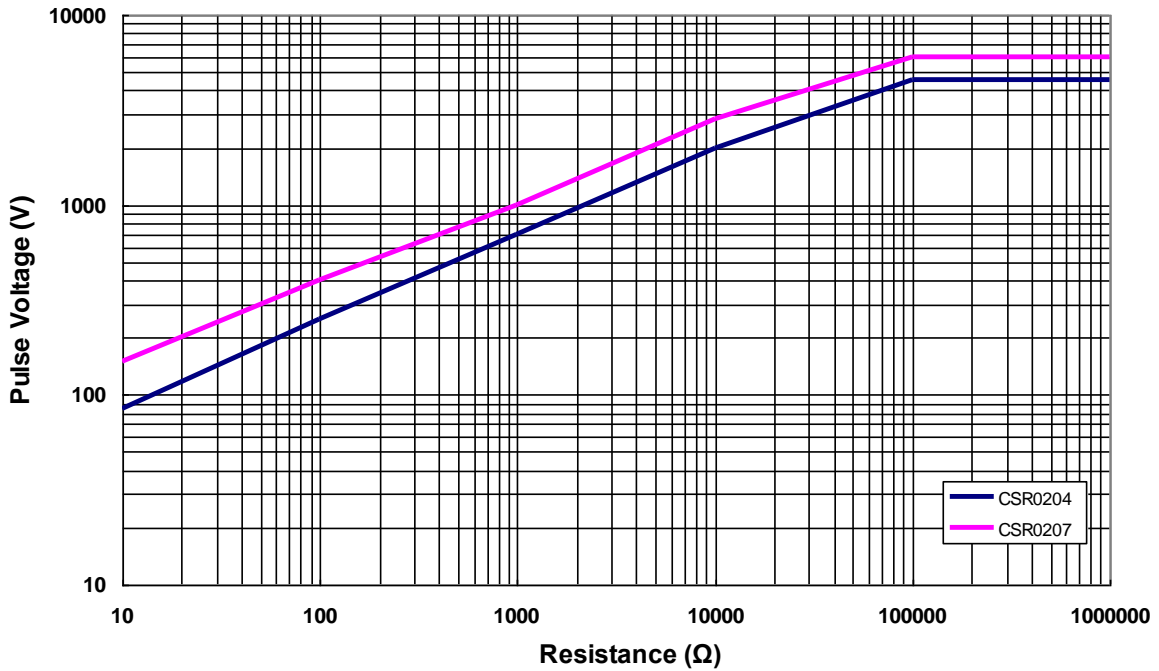

**10/700μs Lightning Surge**

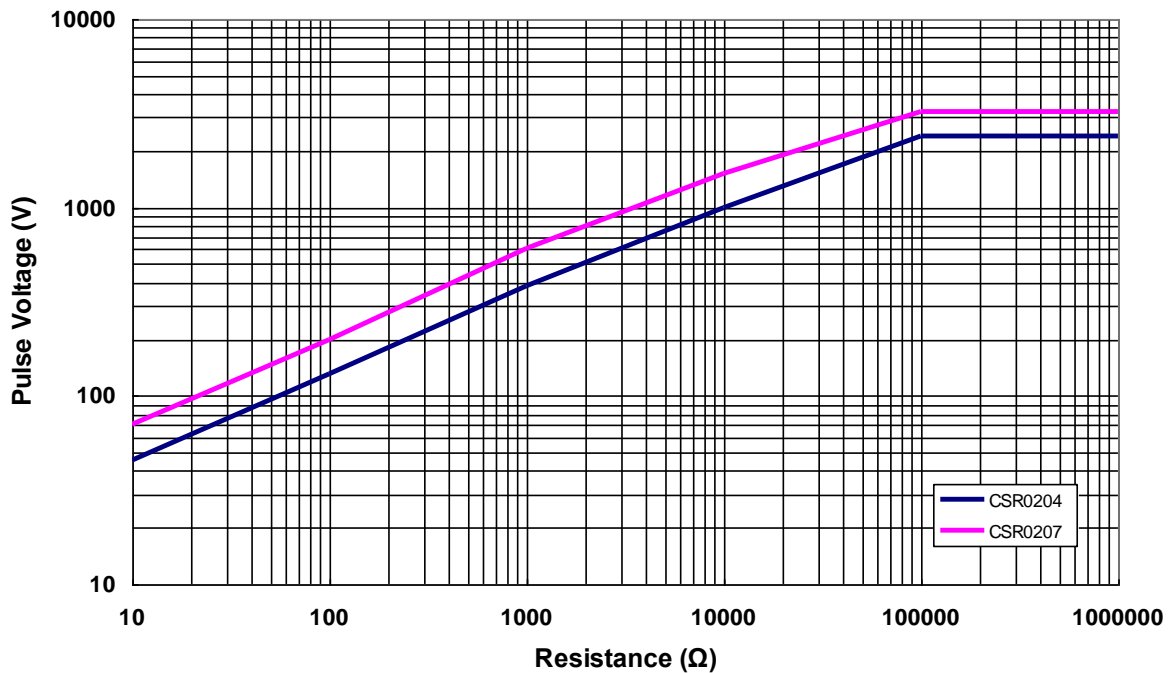

**Metal Film Precision Resistor**

**■ Marking & Resistance Tolerance**

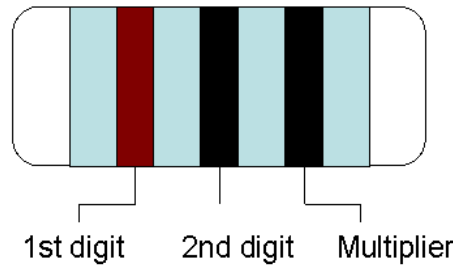

±5%	E-24	1.0	1.1	1.2	1.3	1.5	1.6	1.8	2.0	2.2	2.4	2.7	3.0	3.3	3.6	3.9	4.3	4.7	5.1	5.6	6.2	6.8	7.5	8.2	9.1
-----	------	-----	-----	-----	-----	-----	-----	-----	-----	-----	-----	-----	-----	-----	-----	-----	-----	-----	-----	-----	-----	-----	-----	-----	-----

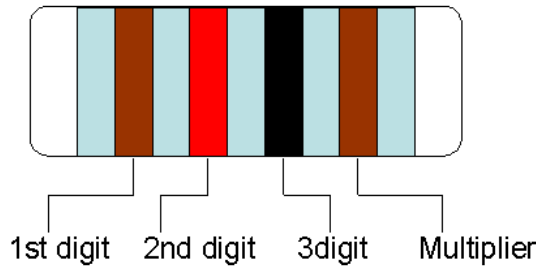

±1%	E-96	1.00	1.02	1.05	1.07	1.10	1.13	1.15	1.18	1.21	1.24	1.27	1.30	1.33	1.37	1.40	1.43	1.47	1.50	1.54	1.58	1.62	1.65	1.69	1.74
		1.78	1.82	1.87	1.91	1.96	2.00	2.05	2.10	2.15	2.21	2.26	2.32	2.37	2.43	2.49	2.55	2.61	2.67	2.74	2.80	2.87	2.94	3.01	3.09
		3.16	3.24	3.32	3.40	3.48	3.57	3.65	3.74	3.83	3.92	4.02	4.12	4.22	4.32	4.42	4.53	4.64	4.75	4.87	4.99	5.11	5.23	5.36	5.49
		5.62	5.76	5.90	6.04	6.19	6.34	6.49	6.65	6.81	6.98	7.15	7.32	7.50	7.68	7.87	8.06	8.25	8.45	8.66	8.87	9.09	9.31	9.53	9.76
±0.5%	E-192	10.0	10.1	10.2	10.4	10.5	10.6	10.7	10.9	11.0	11.1	11.3	11.4	11.5	11.7	11.8	12.0	12.1	12.3	12.4	12.6	12.7	12.9	13.0	13.2
		13.3	13.5	13.7	13.8	14.0	14.2	14.3	14.5	14.7	14.9	15.0	15.2	15.4	15.6	15.8	16.0	16.2	16.4	16.5	16.7	16.9	17.2	17.4	17.6
		17.8	18.0	18.2	18.4	18.7	18.9	19.1	19.3	19.6	19.8	20.0	20.3	20.5	20.8	21.0	21.3	21.5	21.8	22.1	22.3	22.6	22.9	23.2	23.4
		23.7	24.0	24.3	24.6	24.9	25.2	25.5	25.8	26.1	26.4	26.7	27.1	27.4	27.7	28.0	28.4	28.7	29.1	29.4	29.8	30.1	30.5	30.9	31.2
		31.6	32.0	32.4	32.8	33.2	33.6	34.0	34.4	34.8	35.2	35.7	36.1	36.5	37.0	37.4	37.9	38.3	38.8	39.2	39.7	40.2	40.7	41.2	41.7
		42.2	42.7	43.2	43.7	44.2	44.8	45.3	45.9	46.4	47.0	47.5	48.1	48.7	49.3	49.9	50.5	51.1	51.7	52.3	53.0	53.6	54.2	54.9	55.6
		56.2	56.9	57.6	58.3	59.0	59.7	60.4	61.2	61.9	62.6	63.4	64.2	64.9	65.7	66.5	67.3	68.1	69.0	69.8	70.6	71.5	72.3	73.2	74.1
		75.0	75.9	76.8	77.7	78.7	79.6	80.6	81.6	82.5	83.5	84.5	85.6	86.6	87.6	88.7	89.8	90.9	92.0	93.1	94.2	95.3	96.5	97.6	98.8

Color	Digit	Multiplier
Silver	-	10 <sup>-2</sup>
Gold	-	10 <sup>-1</sup>
Black	0	10 <sup>0</sup>
Brown	1	10 <sup>1</sup>
Red	2	10 <sup>2</sup>
Orange	3	10 <sup>3</sup>
Yellow	4	10 <sup>4</sup>
Green	5	10 <sup>5</sup>
Blue	6	10 <sup>6</sup>
Violet	7	10 <sup>7</sup>
Grey	8	10 <sup>8</sup>
White	9	10 <sup>9</sup>

※Resistance more than two significant figures(<1R) or more than three significant figures(>1R) will not provide color code.

**REVISION HISTORY**

REVISION	DATE	CHANGE NOTIFICATION	DESCRIPTION
Version B9	Jun 03, 2014	-	- Electrical Specifications updated - Environmental Characteristics updated
Version C	Feb 25, 2015	-	- Max overload voltage updated - Increase the color code Description
Version C1	Apr 30, 2015	-	- Electrical Specifications updated (CSR0102) - Dimension "K" updated
Version C2	Jul 07, 2015	-	- Increase CSR0102 Characteristic Curve
Version C3	Jul 15, 2016	-	- Modify Storage Temperature - Remove CSR0102 specification
Version C4	Jun 01, 2017	-	- Electrical Specifications updated
Version C5	Jan 12, 2018	-	- Electrical Specifications updated - Increase L1 & $\Phi$ D1 Dimension - Environmental Characteristics updated
Version C6	May 20, 2019	-	- Modify TCR Test description
Version C7	Mar 31, 2020	-	- Increase 5ppm specification range
Version C8	Jun 30, 2020	-	- Increase 5ppm specification range
Version C9	Mar 10, 2021	-	- Modify Soldering Condition (IPC/JEDEC J-STD-020) - Electrical Specifications updated
Version D	Sep 3, 2021	-	- Modify Pulse Curve
Version D1	Sep 28, 2021	-	- Add in Shelf Life: 2 years from production date.
Version D2	Jan 05, 2022	-	- Newly added antistatic tape packaging for packaging methods.
Version D3	Feb 15, 2022	-	- Derating Curve changes the temperature range.
Version D4	Jun 15, 2022	-	- Modify Soldering Condition